

Odd-even Effects on the Surface Anchoring Strength and the Pretilt Angle Generation in NLC on Rubbed Polythiophene Surfaces with Alkyl Chain Lengths

12-1-10

Dae-Shik Seo

Abstract

We have investigated that the high pretilt angle of the NLC, 4-n-pentyl-4-cyanobiphenyl (5CB), was observed on rubbed polythiophene (PTP) surfaces with alkyl chains with more than 10 carbon atoms; it is attributed to the surface-excluded volume effect by the alkyl chain lengths between the LCs and the PTP surfaces. Next, we investigated that the odd-even effect of the polar anchoring strength in 5CB on rubbed PTP surfaces with alkyl chain lengths has been successfully evaluated. The anchoring strength of 5CB for rubbed PTP surfaces with odd-number is weak compared with even-number up to the 6 carbon atoms in the alkyl chain; however, odd-number is strong compared with even-number above 7 carbon atoms. The weak anchoring strength of 5CB is strongly attributed to the high pretilt angle on rubbed PTP surface above 7 carbon atoms. The anchoring energy of 5CB is approximately 1×10^{-3} (J/m²) on rubbed PTP surface with 7 carbon atoms; it is relatively strong anchoring strength. Consequently, we conclude that the odd-even effects of the polar anchoring strength in NLCs are strongly related to the characteristics of the polymer and observed clearly for short alkyl chain lengths.

Key Words : Nematic liquid crystal(NLC), Polythiophene surface, Pretilt angle, Extrapolation length, Polar anchoring strength

1. INTRODUCTION

Uniform alignment of liquid crystals (LCs) on substrate surfaces is very important in LC science and technology. Interfacial properties between the LCs and the alignment surfaces are the key to understand the alignment mechanism of LCs.¹⁾ Rubbed polyimide (PI) surfaces have been widely used to align LC molecules in industrial applications. Nowadays, uniform alignment of LCs with a high pretilt angle is very important for the properly operating super-twisted nematic LC display (STN-LCD).

The pretilt angle generation in NLC on various alignment layers by unidirectional rubbing was demonstrated and discussed by many investigators.²⁻⁶⁾

In a previous work, we have reported the generation of pretilt angle in 5CB on rubbed polypyrrole (PP) surfaces with different counter ions.⁷⁾ Pretilt angles of about 3~6° of 5CB have been generated on rubbed PP surfaces with large counter ions (R_cO₄). However, the PP surface as an alignment layer is unstable on heat treatment. Also, we have reported the generation of pretilt of 5CB on rubbed PTP surface; it was shown that the high pretilt angle in 5CB successfully observed.⁸⁾ We also reported the first measurement of the temperature dependence of the polar (out-of-plane tilt) anchoring strength of weakly rubbed PI surface in 5CB.⁹⁾ Also, we reported the effects of rubbing and the temperature dependence of polar anchoring

* : 숭실대학교 공대 전기공학과
(서울시 동작구 상도 5동 1-1, Fax: 02-820-0667
E-mail : dsseo@elec.pwri.soongsil.ac.kr)
1998년 10월 26일 접수, 1998년 11월 24일 심사완료

strength of aligned NLC on PI-LB surface.¹⁰⁾ More recently, we have reported the odd-even effects of the polar anchoring strength of 5CB on rubbed PI-Langmuir-Blodgett (LB) surfaces with varying alkyl chain lengths.¹¹⁾ It is demonstrated that the polar anchoring strength of 5CB on rubbed PI-LB surfaces with even-number of carbon atoms in the alkyl chain is stronger than the polar anchoring strength with odd-number of carbon atoms in the alkyl chain.

In this paper, we report the generation of high pretilt angles of 4-n-pentyl-4-cyanobiphenyl (5CB) and the polar anchoring strength of homogeneously aligned NLC, 5CB, on rubbed PTP surfaces with varying alkyl chain lengths by rubbing treatment technique.

2. EXPERIMENTAL

The PTP films were synthesized by electrochemical polymerization using acetonitrile as the solvent and ClO_4 of electrolytes as the counter ions. To obtain a good quality film, 1% water was added to the solvent. The molar ratio of the electrolyte and thiophene was 4:3 in this system. The molecular structure of thiophene is shown in Figure 1. R is the alkyl chain length and used R's are as follows:

R1 : CH_3 , R2 : C_2H_5 , R3 : C_3H_7 , R4 : C_4H_9 ,
 R5 : C_5H_{11} , R6 : C_6H_{13} , R7 : C_7H_{15} , R8 : C_8H_{17}
 R9 : C_9H_{19} , R10 : $\text{C}_{10}\text{H}_{21}$, R11 , $\text{C}_{11}\text{H}_{23}$,
 R12 : $\text{C}_{12}\text{H}_{25}$.

During the polymerization process, the temperature of the solution was maintained at 0°C , and the current density was set at about $0.63 \text{ (mA/cm}^2\text{)}$ and was applied for 40 sec. The PTP films were rubbed using a machine equipped with a nylon roller (Yo-15-N, Yoshikawa Chemical Industries Co., Ltd.). The definition of the rubbing strength, RS was given in previous papers.^{4,5)} LC cells were assembled with the

antiparallel to rubbing direction. The LC layer thickness was set at $60 \pm 0.5 \mu\text{m}$. Pretilt angles were measured by the crystal rotation method for values up to 10° and the magneto capacitive null method was used for values above 10° , and all measurements were done at room temperature (22°C).

Next, we measured the anchoring strength by using "high electric-field techniques".^{11,12,13)} We measured the optical retardation (R) and the electric capacitance (C) as a function of applied voltage (V) in order to determine the polar anchoring strength. Figure 2 shows the measuring system of polar anchoring strength. The optical retardation measurement system consists of a polarizer, an acousto-optic modulator, and an analyzer. The output signal is detected by a photodiode. The electric capacitance of the LC cell is obtained by measuring the out-of-phase component of the current produced by changing the voltage applied to the cell. The extrapolation length d_e is determined by using the relationship between the measured values of the electric capacitance and the optical retardation :

$$\frac{R}{R_0} = \frac{I_0}{CV} - \frac{2d_e}{d} \quad , \quad \text{when } V \gg 6V_{th} \quad (1)$$

where I_0 is a proportional constant depending on the LC materials; V and d stand for the applied voltage and LC medium thickness, respectively.

The polar anchoring energy A is obtained from following relation:

$$A = K / d_e \quad (2)$$

where K is the effective elastic constant which is given by $K = K_1 \cos^2 \theta_0 + K_3 \sin^2 \theta_0$, where K_1 , K_3 , and θ_0 stand for the elastic constant of the splay and bend deformation, and the pretilt angle, respectively. We used the measured elastic constants in this work.

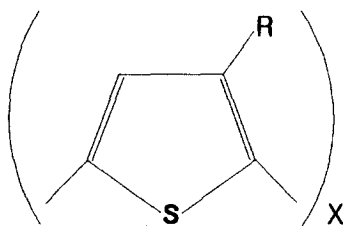

Fig. 1. Molecular structure of thiophene.

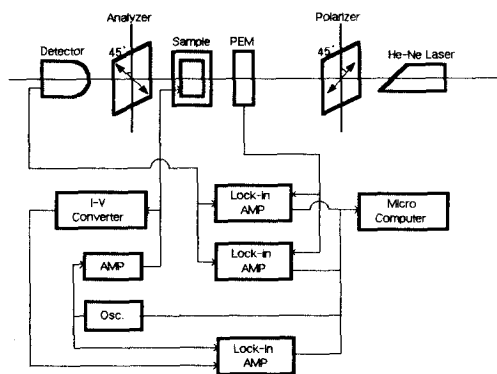

Fig. 2. Measuring system of anchoring strength.

3. RESULTS AND DISCUSSION

Figure 3 shows the generation of pretilt angle generation in 5CB on rubbed PTP surfaces as a function of the alkyl chain length. It was shown that the generated pretilt angle of 5CB is about 0° for small alkyl chain lengths. However, high pretilt angles of about 15~80° were observed with alkyl chain with 10 or more carbon atoms on rubbed PTP surface ; it is stable for medium values of RS. It is considered that this high pretilt angle of 5CB is generated due to the surface-excluded volume effect by the alkyl chain lengths between the LCs and the PTP surfaces.

Figure 4 (a) and (b) show the dependence of the rubbing strength on the pretilt angle of 5CB on rubbed PTP surfaces for alkyl chains of R1~R4 and R5~R8, respectively. It is clear that the pretilt angle of 5CB is very small for all these chains of R1~R8. We believe that the effect

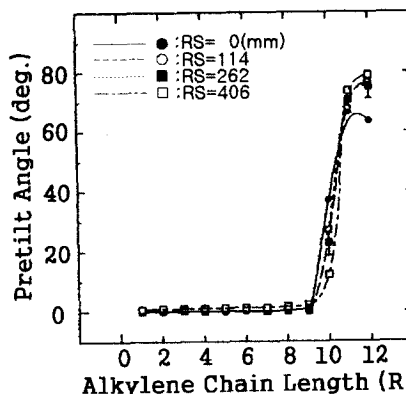
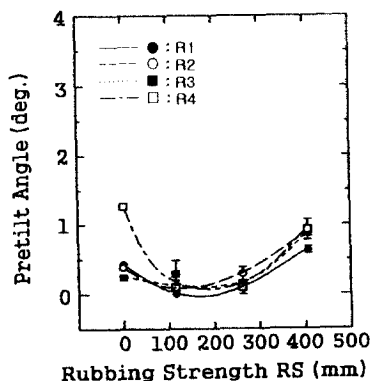
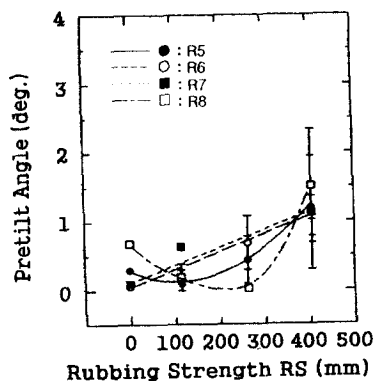

Fig. 3. Generation of pretilt angle of 5CB on rubbed PTP surfaces as a function of alkyl chain lengths.



(a) R1-R4



(b) R5-R8

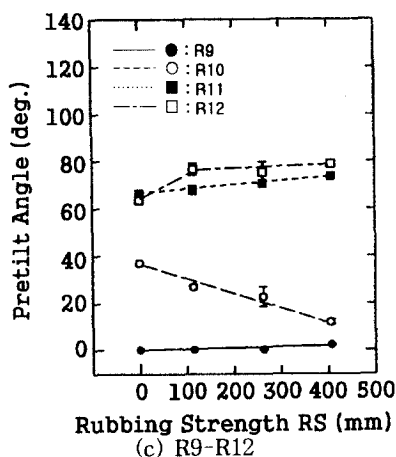

Fig. 4. Generation of pretilt angle in 5CB on rubbed PTP surface with alkyl chain lengths as a function of rubbing strength.

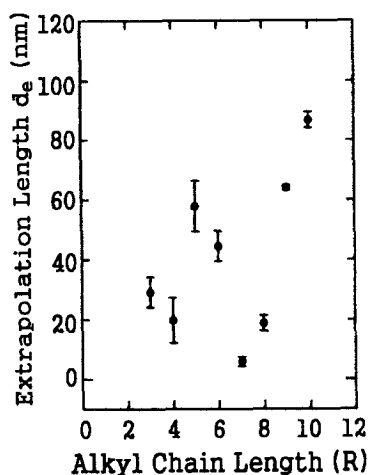

Fig. 5. Extrapolation length of 5CB on rubbed PTP surface for medium rubbing (RS=262mm) as a function of alkyl chain lengths.

due to the alkyl chain length is very small at these alkyl chain lengths. The pretilt angles of 5CB on rubbed PTP surfaces with alkyl chain of R9~R12 as a function of rubbing strength are shown in Figure 4 (c). For the alkyl chain with R9, pretilt angle increases with the RS, and saturates at about 5°. The high pretilt angles

of 5CB were observed for the alkyl chains with R10. The pretilt angle of 5CB is about 38° at RS=0mm, and then decreases with the RS. We observed with microscopic photographs that alignment is not uniform at RS=0mm and that a uniform alignment starts to appear at RS=100mm. The measured pretilt angle is about 25° at medium RS region (RS=100~300mm) and does not vary much. Also, high pretilt angles of about 70~80° of 5CB were observed on surfaces with alkyl chains R11 and R12. This alignment of LC is almost like the homeotropic structure. We suggest that this high pretilt angle of 5CB on these rubbed PTP surfaces are due to the surface-excluded volume effect by the alkyl chains between the LCs and the PTP surfaces. In Figure 4 (c), the odd-even effects is clearly visible. It is sure that the pretilt angle of 5CB on rubbed PTP surfaces with alkyl chains with even-number of carbon atoms is larger compared with the odd-number of carbon atoms. Therefore, we suggest that the odd-even effects on rubbed PTP surfaces is clearly contributed to the high pretilt angle generation.

Next, we investigated that the odd-even effects of the polar anchoring strength in 5CB on rubbed PTP surfaces with alkyl chain lengths has been successfully evaluated. Figure 5 shows the extrapolation length of 5CB on rubbed PTP surface for medium rubbing as a function of alkyl chain lengths. It is shown that the extrapolation length of 5CB for rubbed PTP surface with even-number is relatively small compared with odd-number alkyl chain lengths up to the alkyl chain length- R6. However, it is observed that the extrapolation length of 5CB for rubbed PTP surface with odd-number is relatively small compared with even-number above alkyl chain length of R7. It is considered that the anchoring strength of 5CB on rubbed PTP surfaces with even-number is strong compared with odd-number of carbons up to the alkyl chain length of R6; however, the anchoring strength of 5CB on rubbed PTP surfaces with even-number is weak compared with odd-number above the alkyl chain length of R7. Previously, we reported

that the polar anchoring strength of 5CB with a high pretilt angle is very weak because of the combination of the microsurface excluded volume effect and the van der Waals interaction between the LC molecules and the substrate surface on weakly rubbed PI surface containing trifluoromethyl moieties.¹⁴⁾ From these results, we consider that the large extrapolation length of 5CB is strongly attributed to the high pretilt angle on rubbed PTP surface above the alkyl chain lengths of R7.

The anchoring energy of 5CB on rubbed PTP surface for medium rubbing as a function of alkyl chain length is shown in Figure 6. In this work, we determined that the polar anchoring energy of 5CB at 30°C on rubbed PTP surfaces at the alkyl chain length of R7 for medium rubbing (RS=262mm) is about 1×10^{-3} (J/m²), which indicates strong anchoring. Also, we consider that the polar anchoring strength of 5CB for rubbed PTP surfaces with numbers of R7 and R8 alkyl chain length is stabilized compared with numbers of R3, R4, R5, R6, R10 and R11 alkyl chain lengths. From these results, we suggest that the

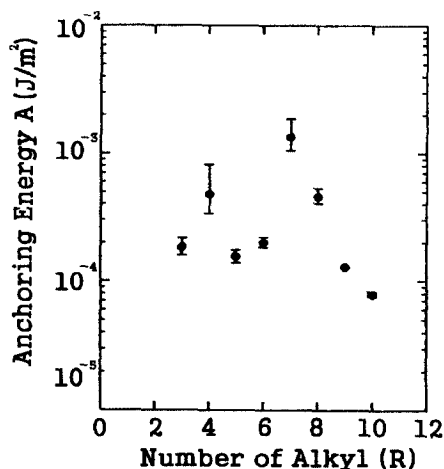

Fig. 6. Anchoring energy of 5CB on rubbed PTP surface for medium rubbing (RS=262mm) as a function of alkyl chain lengths.

polar anchoring strength of 5CB strongly depends on the alkyl chain length on rubbed PTP surface; the odd-even effects of the polar anchoring strength is clearly observed for short alkyl chain lengths.

IV. CONCLUSION

In conclusion, we have investigated the high pretilt angles in 5CB have been generated on rubbed PTP surfaces with longer alkyl chain lengths. We obtained pretilt angle of 25° on these surfaces with 10 carbon atom in the alkyl chain and it is stable for medium values of RS. We suggest that this high pretilt angle generation of 5CB is due to the surface-excluded volume effect by the alkyl chain lengths between the LCs and the PTP surfaces. Also, we investigated that the extrapolation length of 5CB for rubbed PTP surfaces with odd-number is large compared with even-number up to the 6 carbons of alkyl chain length-R6; however, odd-number is small compared with even numbers above the 7 carbon atoms of alkyl chain length-R7. It is considered that the large extrapolation length of 5CB is strongly attributed to the high pretilt angle on rubbed PTP surface above the 7 carbon atoms of alkyl chain length-R7. Also, we consider that the anchoring energy of 5CB is about 1×10^{-3} (J/m²) on rubbed PTP surface at the 7 carbons of alkyl chain length-R7; it is relatively strong anchoring strength. Consequently, we conclude that the odd-even effects of the polar anchoring strength in NLC are strongly related to the characteristics of the polymer and observed clearly for short alkyl chain lengths.

Acknowledgment

This research was supported by the Grant of Hackshim Project (971-0911-066-2) of Korea Science & Engineering Foundation.

References

1. H.Yokoyama, "Surface anchoring of nematic liquid crystals", *Mol.Cryst.Liq.Cryst.*, Vol. 165, 269-316 (1988).
2. J.M.Geary, J.W.Goodby, A.R.Kmetz, and J.S.Patel, "The mechanism of polymer alignment of liquid-crystal materials", *J.Appl.Phys.*, Vol. 62, 4100-4108(1987).
3. T.Sugiyama, S.Kuniyasu, D.-S.Seo, H.Fukuro, and S.Kobayashi, "A simple model for pretilted nematic liquid crystal medium and its torsional surface coupling strength", *Jpn.J.Appl.Phys.*, Vol. 29, 2045-2051 (1990).
4. D.-S.Seo, K.Muroi, and S.Kobayashi, "generation of pretilt angle in nematic liquid crystal, 5CB, media aligned polyimide films prepared by spin-coating and LB techniques : effect of rubbing", *Mol.Cryst.Liq.Cryst.*, Vol. 213, 223-228 (1992).
5. D.-S.Seo, S.Kobayashi, and M.Nishikawa, "Study of the pretilt angle for 5CB on rubbed polyimide films containing trifluoromethyl moiety and analysis of the surface atomic concentration of F/C(%) with an electron spectroscope for chemical analysis", *Appl.Phys.Lett.*, Vol. 61, 2392-2394 (1992).
6. M.Nishikawa, N.Bessho, T.Natsui, Y.Ohta, N.Yoshida, D.-S.Seo, Y.Iimura, and S.Kobayashi, " A model of the unidirectional alignment accompanying pretilt angle of nematic liquid crystal (NLC), 5CB, oriented on the rubbed organic-solvent-soluble polyimide film", *Mol.Cryst.Liq.Cryst.*, Vol. 275, 15-25 (1996).
7. D.-S.Seo, S.Kobayashi, and A.Mochizuki, "Generation of the pretilt angles in nematic liquid crystal (5CB) aligned on the rubbed polypyrrole films", *Appl.Phys.Lett.*, Vol. 60, 1025-1027 (1992).
8. D.-S.Seo, S.Kobayashi, M.Nishikawa, and Y.Yabe, "A study of high pretilt angle generation in nematic liquid crystal (5CB) on rubbed polythiophene surfaces with alkyl chain lengths", *Jpn.J.Appl.Phys.*, Vol. 35, 3531-3532 (1996).
9. D.-S.Seo, Y.Iimura, and S.Kobayashi, "Temperature dependence of the polar anchoring strength of weakly rubbed polyimide films for the nematic liquid crystal (5CB)", *Appl.Phys.Lett.*, Vol. 61, 234-236 (1995).
10. D.-S.Seo, S.Kobayashi, D.-Y.Kang, and H.Yokoyama, "Effects of rubbing and temperature dependence of polar anchoring strength of homogeneously aligned nematic liquid crystal on polyimide Langmuir-Blodgett orientation films", *Jpn.J.Appl.Phys.*, Vol. 34, 3607-3611 (1994).
11. D.-S.Seo, S.Kobayashi, M.Nishikawa, J.-H.Kim, and Y.Yabe, "Odd-even effects of the polar anchoring strength in nematic liquid crystal on rubbed polyimide Langmuir-Blodgett films with alkyl chain lengths", *Appl.Phys.Lett.*, Vol. 66, 1334-1336 (1995).
12. H.Yokoyama and H.A.van Sprang, "A novel method for determining the anchoring energy function at a nematic liquid crystal-wall interface from director distortions at high fields", *J.Appl.Phys.*, Vol. 57, 4520-45 (1985).
13. H.Yokoyama, S.Kobayashi, and H.Kamei, "Temperature dependence of the anchoring strength at a nematic liquid crystal-evaporated SiO interface", *J.Appl.Phys.*, Vol. 61, 4501 (1987).
14. D.-S.Seo and S.Kobayashi, "Effect of high pretilt angle for anchoring strength in nematic liquid crystal on rubbed polyimide surface containing trifluoromethyl moieties", *Appl.Phys.Lett.*, Vol. 66, 1202-1204 (1995).